

Projects Executed



Features:

Sheet Roof MMS
3.5MW Short Rails at Tumkur



Features:

Sheet Roof MMS – 600kWp
Short Rails – at Bangalore



Features:

Sheet Roof MMS – 800kWp
Alumimium Short Rails – at Bangalore



Features:

Alumimium Ballast Structure
600kWp– at Kolkata



Features:

Alumimium Ballast Structure
325kWp– at Odisha

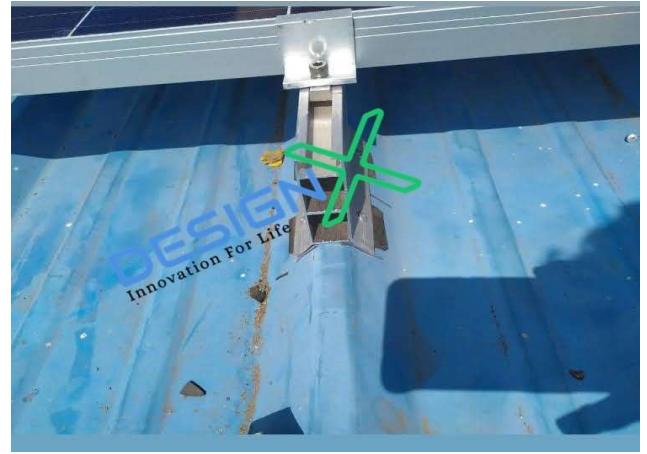

Features:

Alumimium Landscape Rails 80kWp–
at Davangare Karnataka



Features: Sheet Roof MMS – 200kWp Alumimium Long Rails – at Bengaluru

Many More.....

HOT DIP GALVANIZING STRUCTURE



Features:

MS 20kw MS Standard Structure with Hot Dip Galvanized Material
IS 2062 HDG:60to80 MICRONS At Tumkur Karnataka



Features:

MS 40kw MS Standard Structure with Hot Dip Galvanized Material
IS 2062 HDG:60to80 MICRONS At Hassan Karnataka



Features:

MS 72kw MS Standard Structure with Hot Dip Galvanized Material
IS 2062 HDG:60to80 MICRONS- At Chintamani Karnataka



Features:

MS 20kw MS Standard Structure with Hot Dip Galvanized Material
IS 2062 HDG:60to80 MICRONS- At Tumkur Karnataka



Features:

MS 50kw MS Rise Structure with Hot Dip Galvanized Material IS 2062
HDG:60to80 MICRONS- At Electronic city Bangalore Karnataka



FRP WALK WAYS



Features:

Supplied FRP Walkway 25mm 400sq Meter - At Mysuru Karnataka

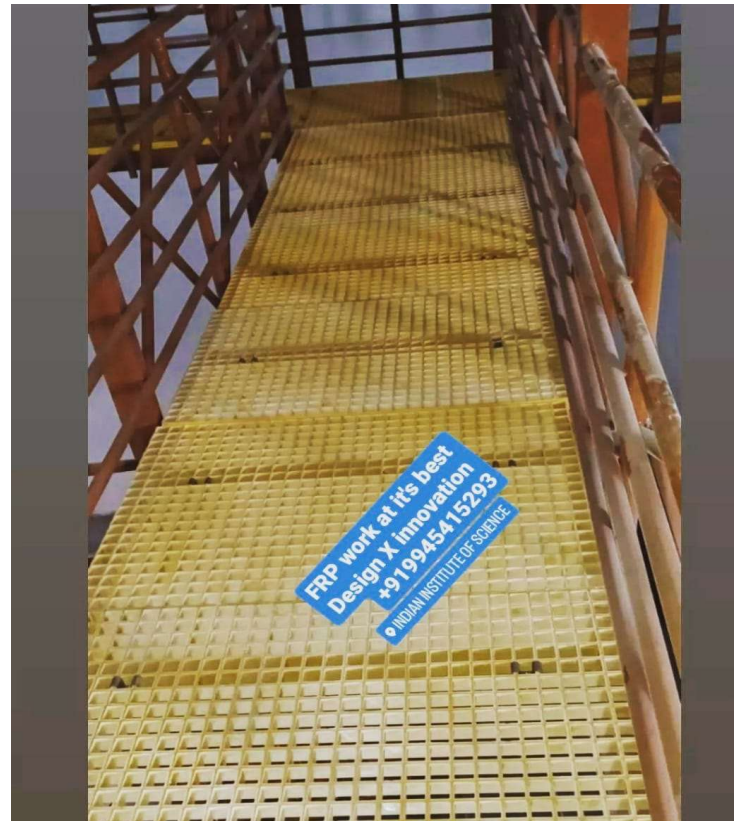

Features:

Supplied FRP Walkway 38mm 180sq Meter - At Indian Institute of Science - Bengaluru



Features:

Supplied FRP Walkway 38mm 80sq Meter For Gutter & Drainage - At **Bengaluru**



Features:

Supplied FRP Walkway & Cable Trays

Design engineering services for custom built & elevated mounting structures through group company.

20KW Rise structure

DESIGN X

+91 -9945415293
Bangalore

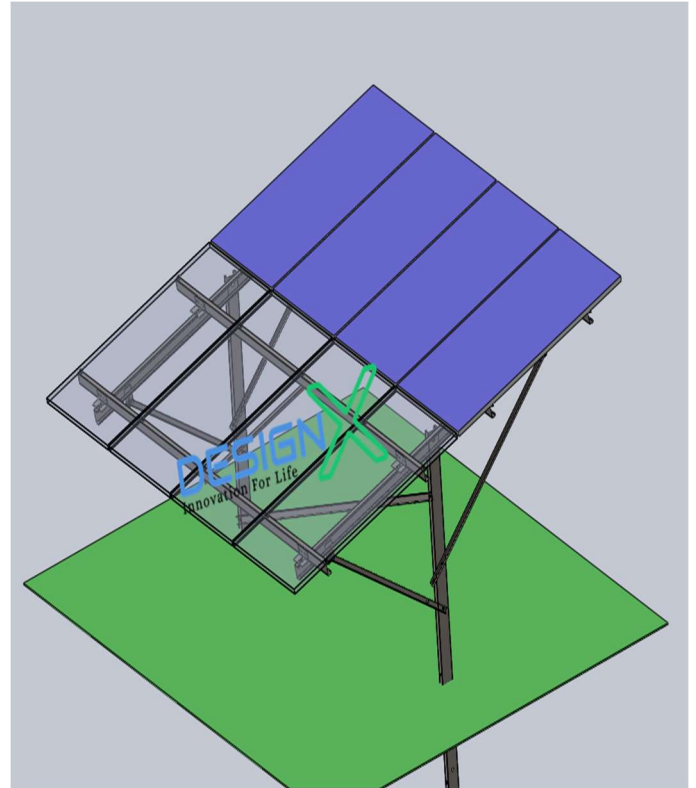
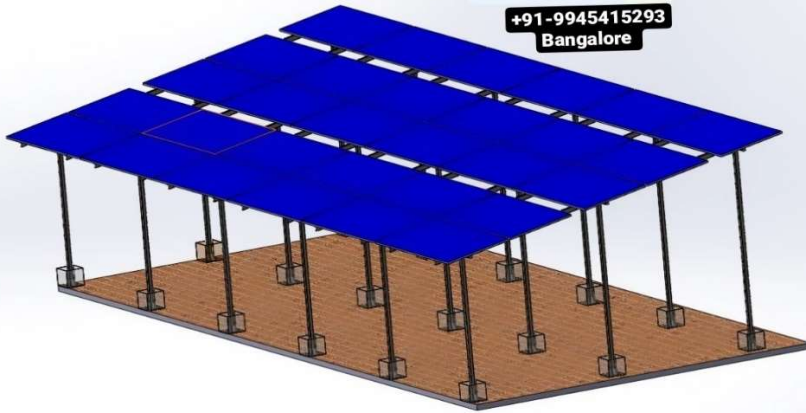

Features:

Pump MS Structure with Hot Dip Galvanized Material

SCALABLE MODULAR SOLAR CARPORT SYSTEMS

Design X Innovation
+91 9945415293

SOLUTION FOR:

- ➔ Residential Solar Carport
- ➔ Commercial Solar Carports
- ➔ Industrial Solar Carports

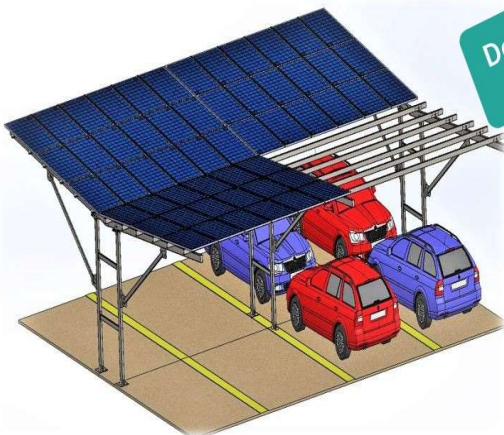

"Supports all commercially available solar panels inverters and exterior rated combiner boxes."

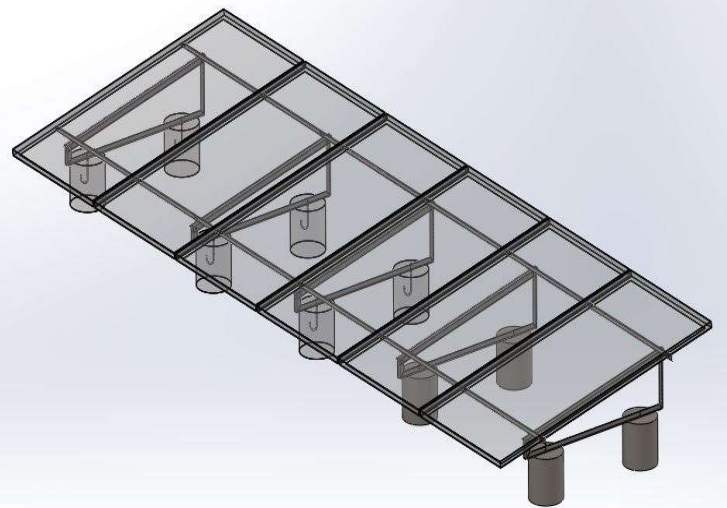

Features:

MS Ballast Structure with Hot Dip Galvanized Material

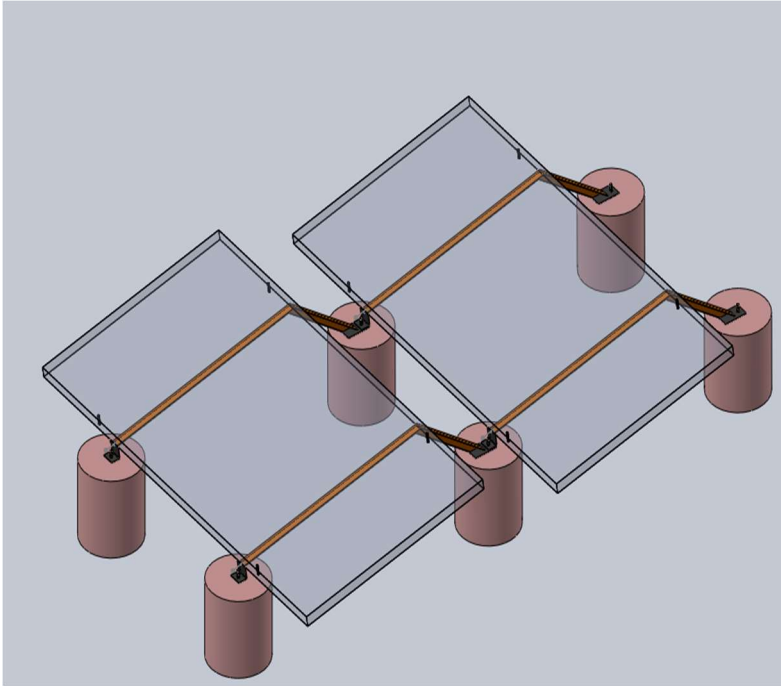

Features:

MS Ballast Structure with Hot Dip Galvanized Material



Features:

MS Rise Structure with Hot Dip Galvanized

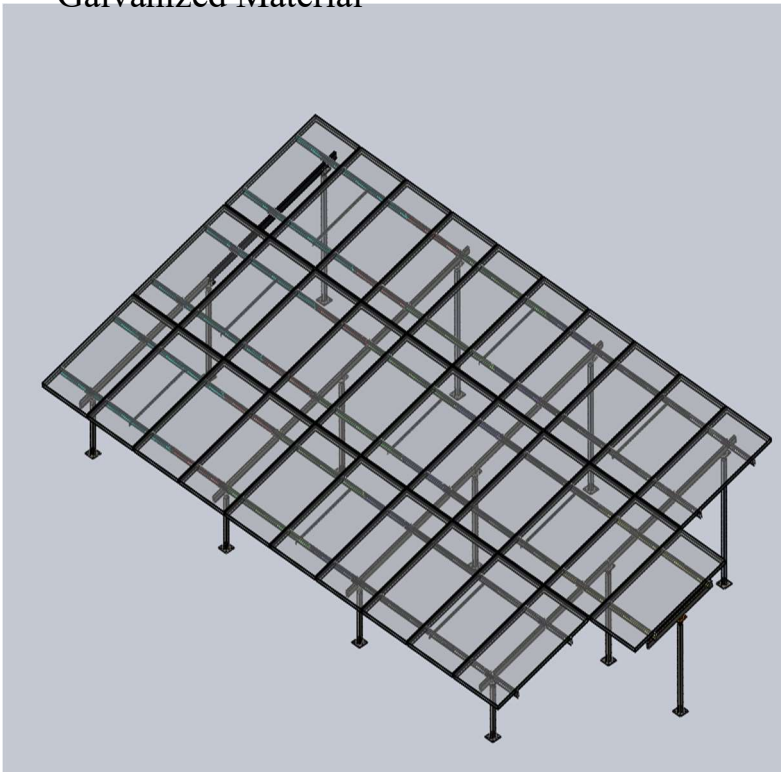

Features:

10kw MS Structure with Hot Dip Galvanized Material

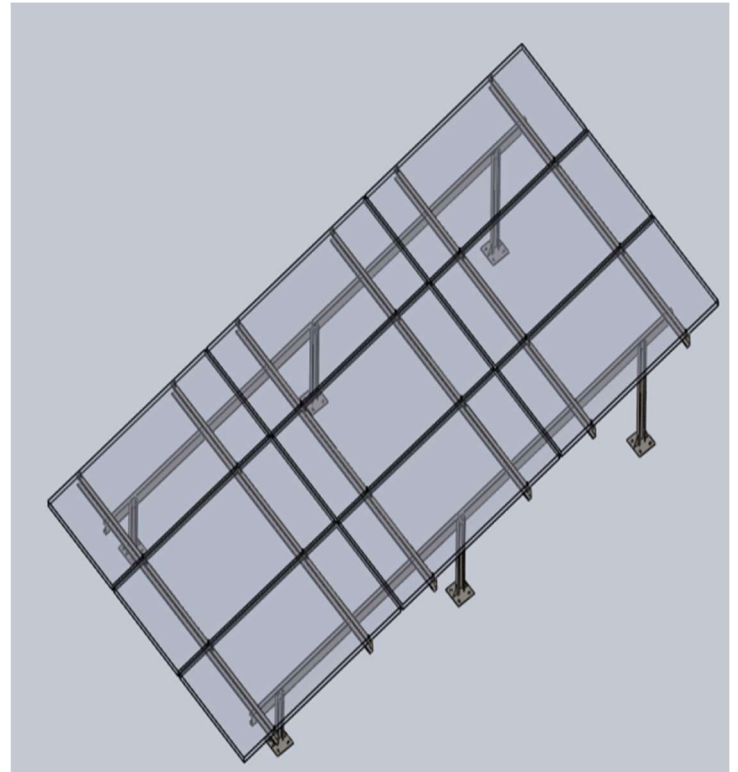

Features:

3kw MS Structure with Hot Dip Galvanized Material

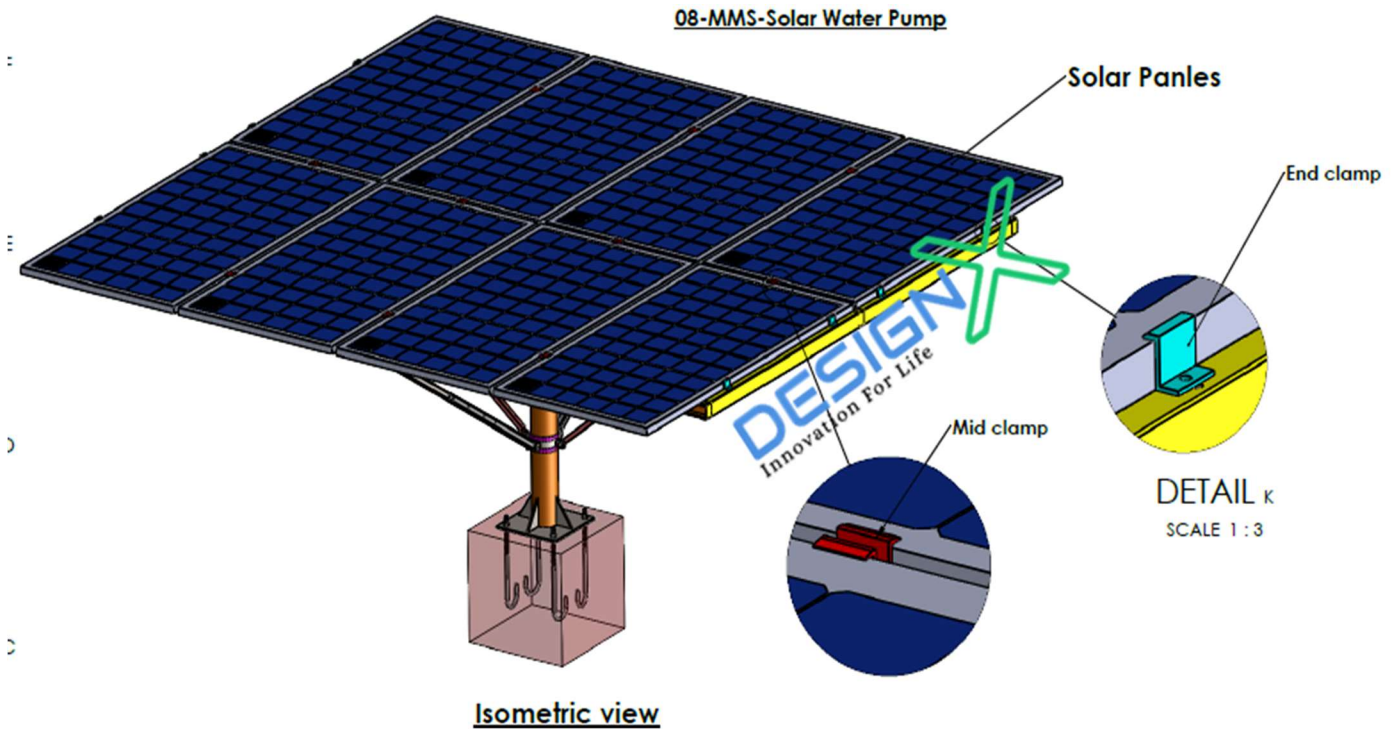

Features:

Solar Water pump Structure with Hot Dip Galvanized Material



JP-NAGAR BANGALORE INDIA – 560078

Mob: +91-9945415293, +91-9663019488

Website: www.designxenp.com

Email: info@designxenp.com

GSTIN:29AATPZ3659D1ZU